

**File 2 suspension 32W/m**

code F2335.930XD/01



**PRODUCT DESCRIPTION**

Direct light indoor suspension lamp made of extruded aluminum 6060; complete with led; color rendering index CRI >90. Professional led modules assembled and wired on extruded aluminum heatsink with high performance reflector, equipped with harmonic steel springs for installation in the profile Tools free, wiring through 5 cables with quick-release terminal blocks, protocol Dimmable Dali. Lamp with color finish white, in polycarbonate with diffusing film. Degree of protection IP40/IP43.

**PRODUCT SPECS**

Installation method	Suspension
Light source	linear LED 32W/mt CRI90
Absorbed power	63 W
Color temperature	3000K
Color rendering index CRI	90
Optic	Microprismatic diffuser
Finishing	White
Luminous flux of the product	5034 lm
Luminous efficiency	80 lm/W
Protocol	Dimmable Dali
Energy efficiency class	D
Dimension	L1985 mm
IP Grade	Inst. Parete Ip40 / Inst. Soffitto Ip43
Power supply	220-240V 50-60Hz

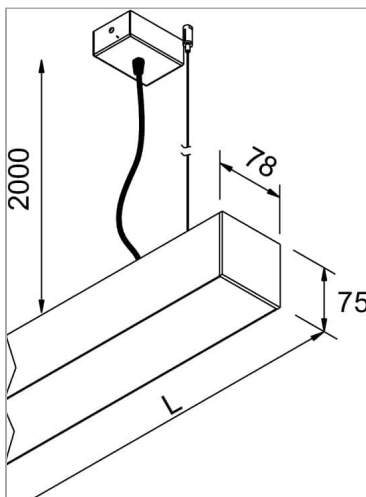

**FILE2 microprismatic LED**

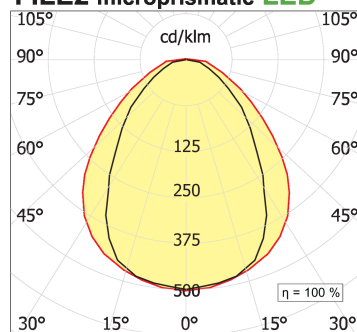

**WEB PAGE**



**ASSEMBLY INSTRUCTIONS**



