

Leva 5 trimless recessed - kit

code LV005K.940S/01

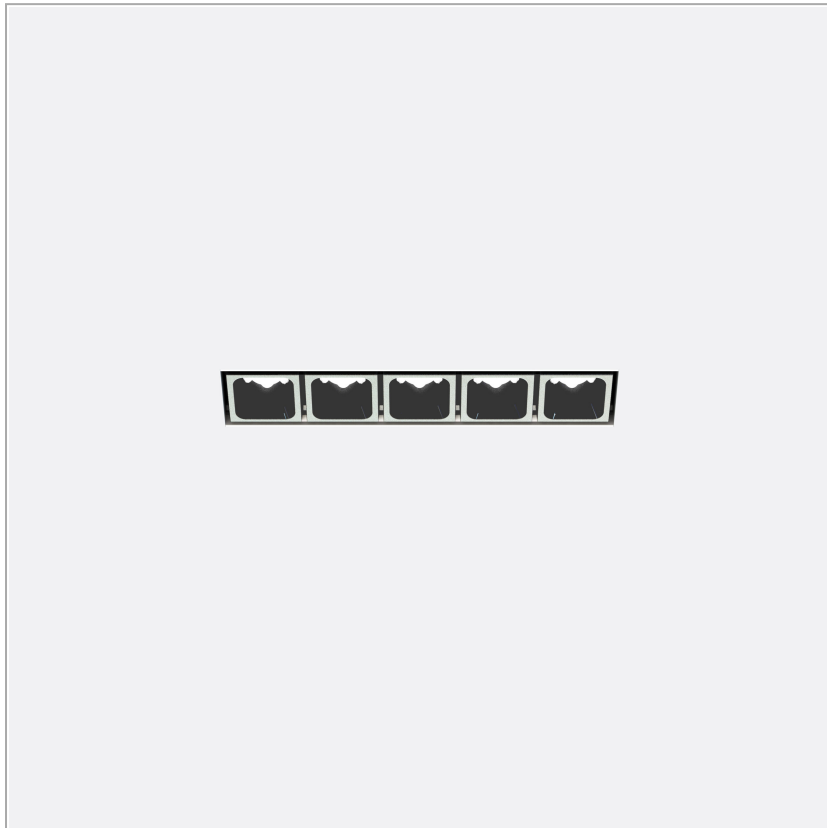

PRODUCT DESCRIPTION

Luminaire for integrated LED Chip On Board sources. Flush-mounted installation. Luminaire body in extruded painted aluminium white. Optical units complete with LED chip on board, lens, anti-glare housing. Optics 20° UGR<16. Degree of protection IP20.

PRODUCT SPECS

Installation method	Trimless recessed
Light source	LED
Absorbed power	5x2,2 W
Color temperature	4000K
Color rendering index CRI	>90
Optic	Spot 20°
Finishing	White
Luminous flux of the product	1025 lm
Luminous efficiency	93 lm/W
MacAdam color tolerance	2
Life time estimate	50000h Ta 25° L90B10
Energy efficiency class	E
Weight	0.10 Kg
Dimension	L150xW27xH60 mm
Hole size	32X156 mm
IP Grade	IP20
Protection Class	Class III appliance
Product Spec	Rectangular shape
Power supply/Transformer	Not included
Protocol	See power supply

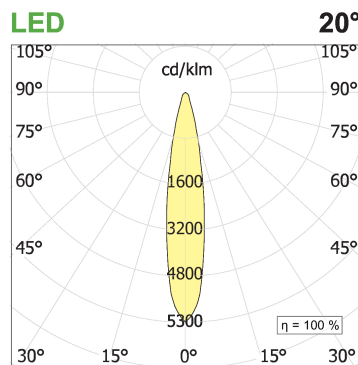
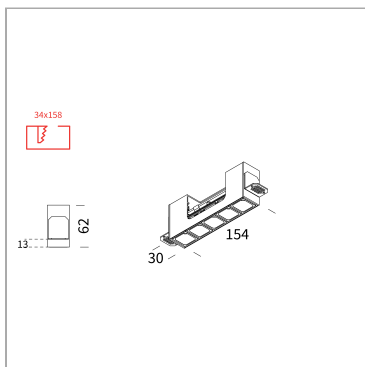

WEB PAGE



ASSEMBLY INSTRUCTIONS



MANDATORY ACCESSORIES

Accessories Leva Trimless box 5



code LV005A

Trimless recessed indoor wallbox for false ceiling

Technical Sheet



AE700.11C (Copia)



code AE700.12C

Electronic power supply current

Technical Sheet



OPTIONAL ACCESSORIES

Wallbox for brick wall and concrete – Leva5

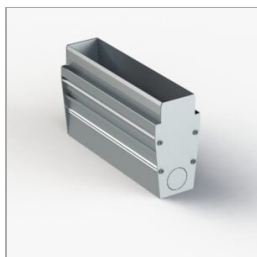

code CCLV05

Formwork for masonry and concrete, suitable for Leva5. Internal length 157mm - external length 159,4mm

Technical Sheet



