

Iride Track 86L

code IR14.935FD/01



PRODUCT DESCRIPTION

Projector for track System indoor tilting/ adjustable complete with led 18 W, beam 24°, color rendering index CRI>90. Color finish white. Body lamp and optical group made of die-cast aluminum powder-coated, aluminum joint, rotation of the optical group of 355 °. on the vertical axis and 90 °. on the horizontal axis. Snooter in lamp finish or finishing choice. High performance lens. Possibility of insertion of Honey Comb filter.

PRODUCT SPECS

Installation method	Track
Light source	LED
Absorbed power	18 W
Color temperature	3500K
Color rendering index CRI	>90
Optic	Flood 24°
Finishing	White
Luminous flux of the product	1832 lm
Luminous efficiency	102 lm/W
MacAdam color tolerance	3
Life time estimate	50000h Ta 25° L80B10
Protocol	Dimmable Dali
Energy efficiency class	D
Dimension	Ø86 mm
Product Spec	Adjustable
Power supply	220-240V 50-60Hz

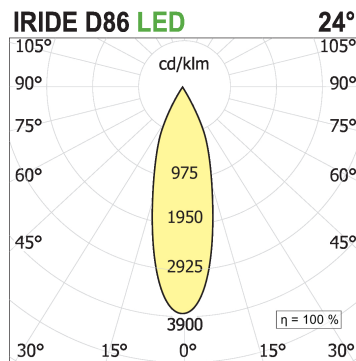
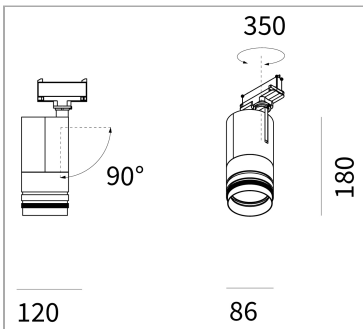

WEB PAGE



ASSEMBLY INSTRUCTIONS

